

TWORZYMY CIEPŁĄ ATMOSFERĘ



Biokominki / Biofireplace / Biokomain / Биокамин / Biokrbv
/ Bio-cheminées / Τζακια βιοκαυσίμου / Biocaminetto / Biochimeneas



Nasze biokominki posiadają certyfikat bezpieczeństwa TÜV

Our biofireplaces acquired a TÜV safety certificate

Unsere Biokamine sind TÜV Rheinland zertifiziert

Наши биокамины сертифицированы TÜV

Our biofireplaces acquired a TUV safety certificate

Nos biocheminées sont certifiées par le TÜV

Οι εστίες βιοαιθανόλης διαθέτουν την πιστοποίηση ασφαλείας TÜV

Nostri biocamini hanno certificato di sicurezza TÜV

Versión con certificado de seguridad TÜV opcional

Nasze Biokominki wyposażone są w bezpieczny bio - pojemnik

Bezpieczny pojemnik biokominka z wkładem absorbującym / chłonnym to nowe rozwiązanie zastosowane w pojemnikach do biokominków. Pozwala on na znaczne zmniejszenie zużycia paliwa, a przede wszystkim wyklucza ryzyko wylania / rozlania się paliwa, nawet w razie przypadkowego przewrócenia się biokominka z palącym się paliwem w pojemniku.

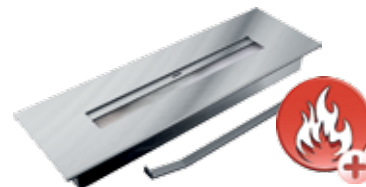

Our Biofireplaces are equipped in safe bio container

Safety container of bio-fireplace with absorbing material inside is a new solution used in bio containers. It allows for a significant reduction in fuel consumption in case of accidental tipping biofireplace, and above all eliminates any risk of spillage of fuel in the event of accidental overturning of bio-fireplace with the the burning fuel in the container.

Unsere Biokamine sind mit einem sicheren Behälter ausgestattet

Sicherer Behälter des Biokamins mit einem Keramikschwamm, der sich durch Saugeigenschaften auszeichnet, ist eine neue Lösung in den Bio-Kaminen. Die Anwendung des Keramikschwamms lässt einerseits den Verbrauch von Bio-Brennstoff sinnvoll reduzieren, vor allem aber schützt vor dem Verschütten des Brennstoffs außerhalb des Behälters, auch wenn er während des Brennprozesses umkippt.

Наши биокамины оснащены в безопасный био - контейнер

Безопасный контейнер для биокамина с абсорбирующим материалом - это новое решение для биоконтейнеров, которое позволяет уменьшить потребление биотоплива и исключает риск разлития этого топлива даже при случайном опрокидывании биокамина во время горения.

Naše biokrby jsou vybaveny bezpečnostním zásobníkem na biopalivo

Bezpečnostní zásobník biokrbu obsahující absorbční materiál je nové řešení používané u biokrbů. Umožňuje výrazné snížení spotřeby paliva a především eliminuje jakékoliv riziko úniku paliva v případě náhodného převrácení biokrbu s hořícím palivem v zásobníku.

Bio-cheminée avec le conteneur sécuritaire

Le contenant sécuritaire du bio-cheminée avec contribution absorbant, c'est nouvelle solution utilisée dans des conteneurs pour les bio-cheminée. Il permet une réduction significative de la consommation de carburant, et surtout à écarter le risque de fuite / déversement de carburant, même en cas de renversement accidentel de la bio-cheminée avec le carburant brûlant dans le conteneur.

Οι διακοσμητικές εστίες βιοαιθανόλης διαθέτουν ένα ασφαλές δοχείο βιοκαυσίμου

Ασφαλές δοχείο για τις εστίες βιοαιθανόλης είναι μία νέα λύση με απορροφητικό ένθετο, το οποίο μειώνει την κατανάλωση βιοαιθανόλης, καθώς και αποτρέπει τυχών ξεχείλισμα του υγρού. Είναι ασφαλές ακόμη σε περίπτωση ατυχήματος με αναμμένη εστία.

I nostri biocamini sono dotati di bruciatori sicuri

Il sicuro contenitore di biocamino, con bruciatore assorbente è una nuova soluzione utilizzata nei contenitori per i biocamini. Tale soluzione permette una significativa riduzione del consumo di carburante, ma soprattutto previene di fuoriuscita di carburante, anche in caso di un ribaltamento di biocamino durante la combustione del carburante nel contenitore.

Biochimeneas con depósito de seguridad

El depósito de seguridad de la biochimenea, con interior absorbente, es la solución más avanzada para este tipo de chimeneas. Permite un significativo ahorro de combustible además de eliminar el riesgo de fugas y de derramamiento, incluso en el caso de vuelco accidental de la biochimenea.



Material: / Material: / Gehäuse: / Материал: / Material: / Material: / Υλικό: / Materiale: / Material:



Waga: / Weight: / Gewicht: / Bec: / Hmotnost: / Poids: / Βάρος: / Peso: / Peso:



Pojemność pojemnika, biowkładki / Capacity of the biocontainer / Volumen des Biobehälter / Емкость био контейнера, био вкладыша / La capacité du récipient / Brûleur / Capacidad del depósito

UWAGA: Pojemnik można zapełnić maksymalnie do 50% jego objętości / NOTE: The container can be filled up to 50% of its volume / HINWEIS: Der Container kann bis zu 50% seines Volumens zu füllen / ВНИМАНИЕ: Контейнер можна заповнити максимально до 50% его объема / ATTENTION: Le récipient peut être rempli jusqu'à maximum 50 % de son volume / NOTA: El depósito puede rellenarse hasta el 50% de su capacidad.

Biochiminek dostępny w wersji z szybą

Biofireplace available with glass as an option

Biokamin erhältlich optional mit dem Schutzglas

Био-камин доступен в версии со стеклом

Biokrb dostupný se sklem, jako volitelným příslušenstvím

Bio-cheminée disponible avec verre

Εστία βιοαιθανόλης διαθέσιμη σε τζάμι



Il biocamino è disponibile con il vetro, come opzione a scelta

Chimenea disponible con cristal protector (opcional)



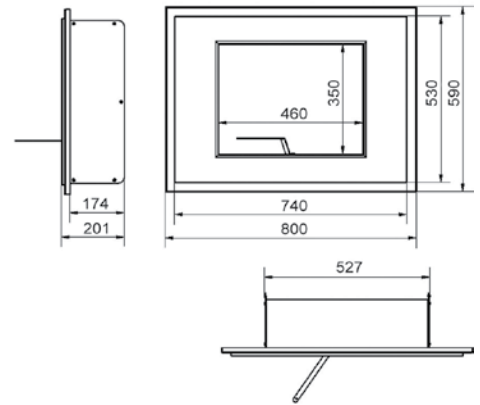



ALPHA

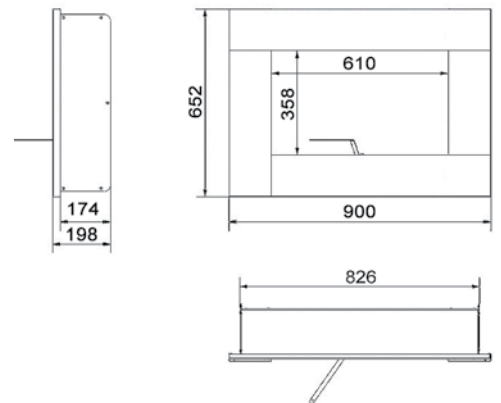

 17
  1,2
 
 stal czarna malowana / black painted steel / Schwarzstahl gestrichen / черная сталь с окраской / černý plech / acier noir peint / μαύρος χάλυβας βαμμένος / lamiera verniciata nera / acero negro pintado



BRAVO

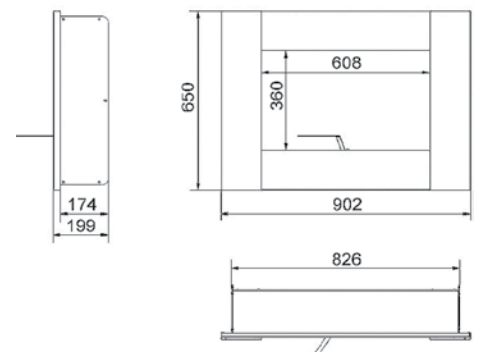

 23,5
  1,2
 
 stal czarna malowana / black painted steel / Schwarzstahl gestrichen / черная сталь с окраской / černý plech / acier noir peint / μαύρος χάλυβας βαμμένος / lamiera verniciata nera / acero negro pintado

BRAVO 2





 23
  1,2
 
 stal czarna malowana / black painted steel / Schwarzstahl gestrichen / черная сталь с окраской / černý plech / acier noir peint / μαύρος χάλυβας βαμμένος / lamiera verniciata nera / acero negro pintado



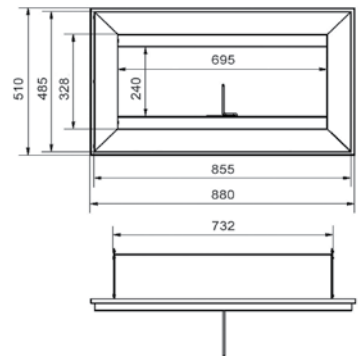
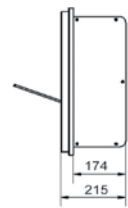



CHARLIE

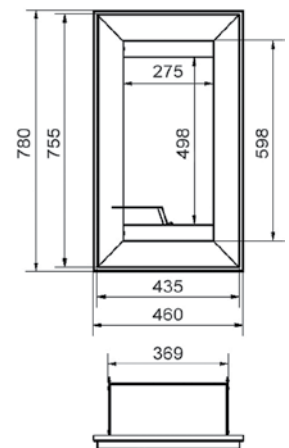
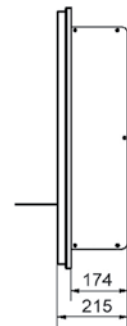

 20
  1,6
  stal czarna malowana / black painted steel / Schwarzstahl gestrichen / черная сталь с окраской / černý plech / acier noir peint / μαύρος χάλυβας βαμμένος / lamiera verniciata nera / acero negro pintado



CHARLIE 2



 20
  1,2
  stal czarna malowana / black painted steel / Schwarzstahl gestrichen / черная сталь с окраской / černý plech / acier noir peint / μαύρος χάλυβας βαμμένος / lamiera verniciata nera / acero negro pintado

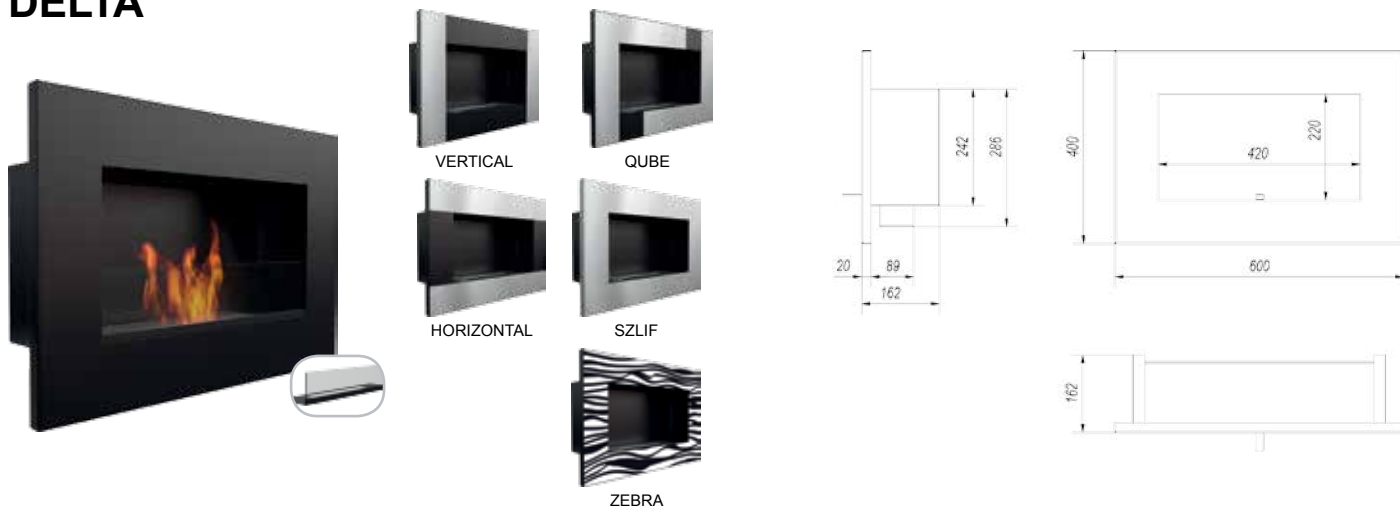

DELTA

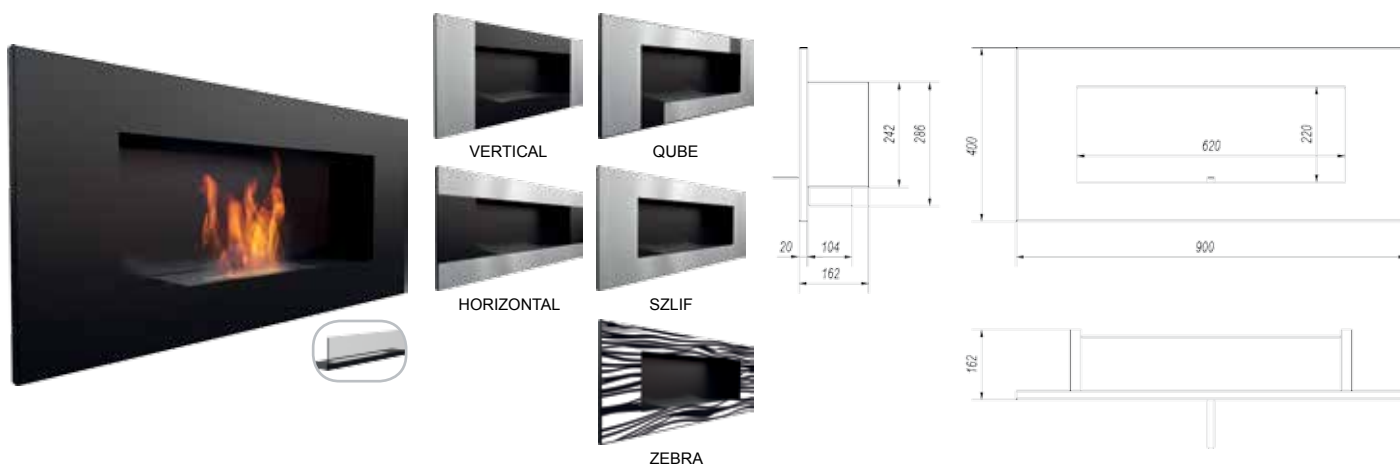

 7
  0,4
 
 stal czarna malowana / black painted steel / Schwarzstahl gestrichen / черная сталь с окраской / černý plech / acier noir
 peint / μαύρος χάλυβας βαμμένος / lamiera verniciata nera / acero negro pintado

DELTA 2





 10
  1,2
 
 stal czarna malowana / black painted steel / Schwarzstahl gestrichen / черная сталь с окраской / černý plech / acier noir
 peint / μαύρος χάλυβας βαμμένος / lamiera verniciata nera / acero negro pintado



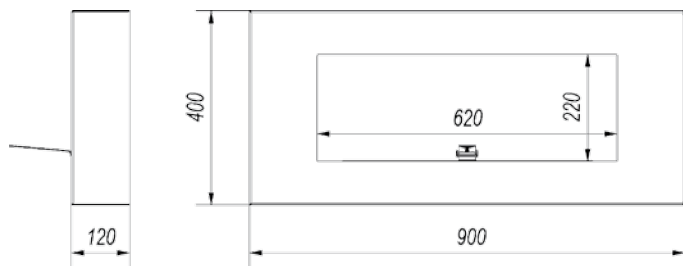



DELTA FLAT

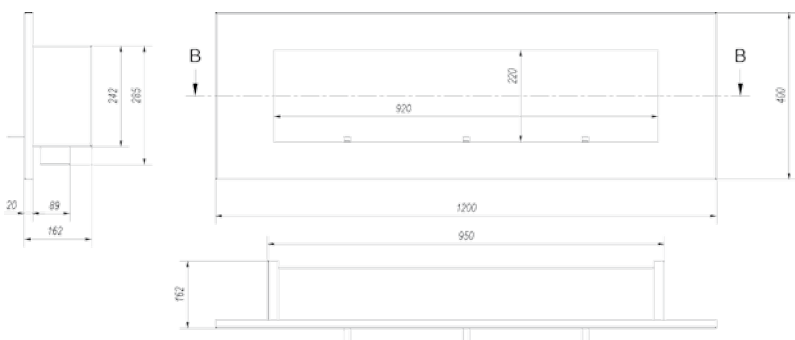

 13,2
  0,75
  stal czarna malowana / black painted steel / Schwarzstahl gestrichen / черная сталь с окраской / černý plech / acier noir peint / μαύρος χάλυβας βαμμένος / lamiera verniciata nera / acero negro pintado



DELTA 3

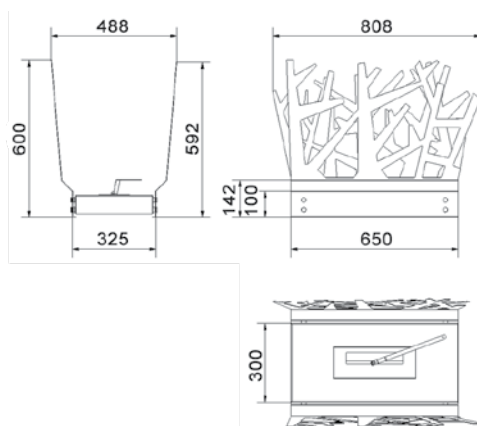

 13,5
  1,2
  stal czarna malowana / black painted steel / Schwarzstahl gestrichen / черная сталь с окраской / černý plech / acier noir peint / μαύρος χάλυβας βαμμένος / lamiera verniciata nera / acero negro pintado

HOTEL KRZAK



 12
  1,2
  stal czarna malowana / black painted steel / Schwarzstahl gestrichen / черная сталь с окраской / černý plech / acier noir peint / μαύρος χάλυβας βαμμένος / lamiera verniciata nera / acero negro pintado

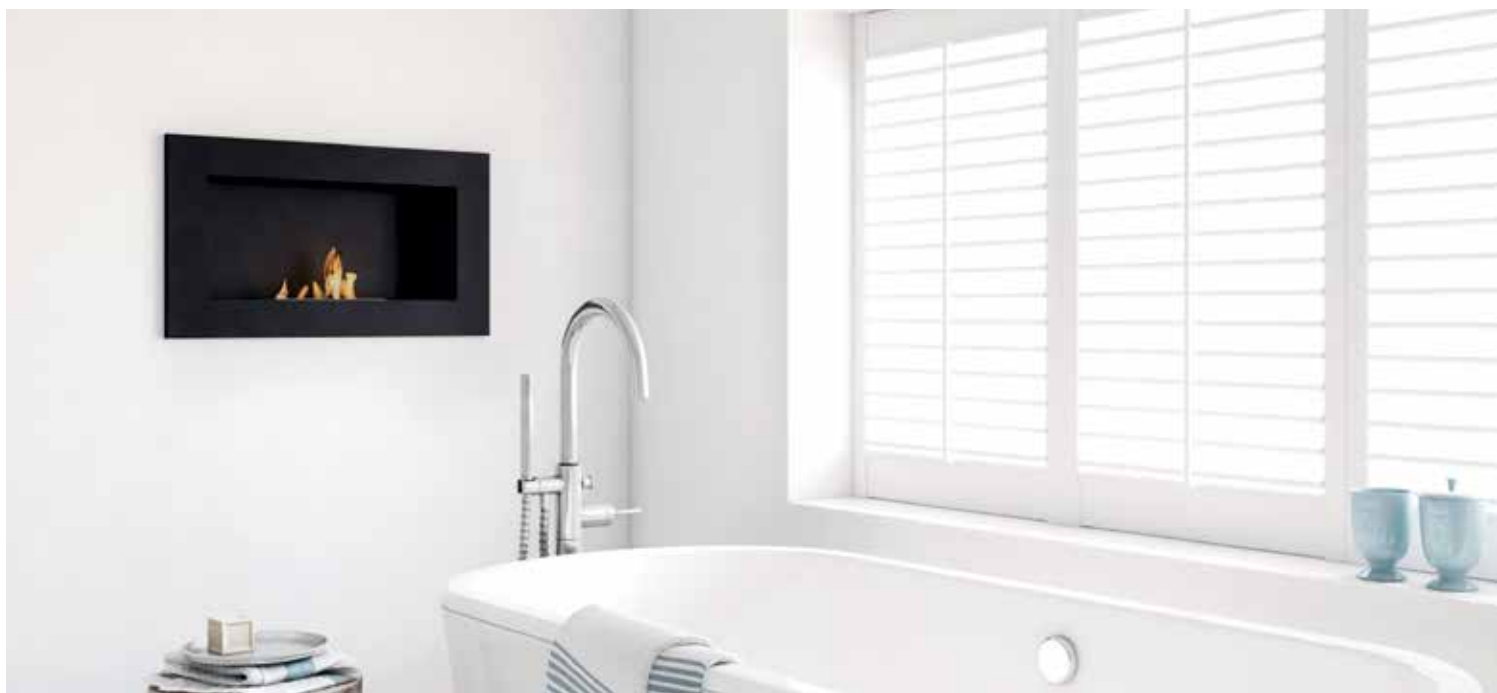

GOLF



VERTICAL



QUBE



HORIZONTAL





SZLF



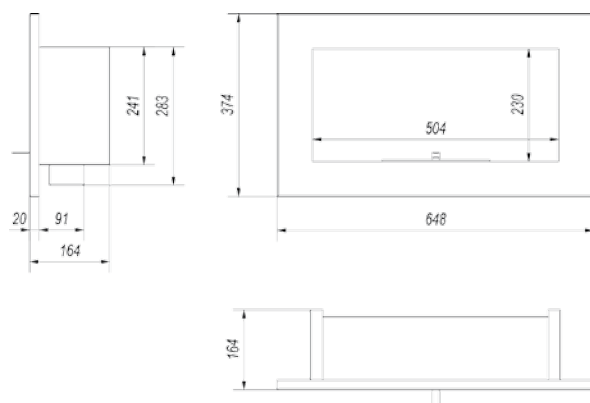



ZEBRA

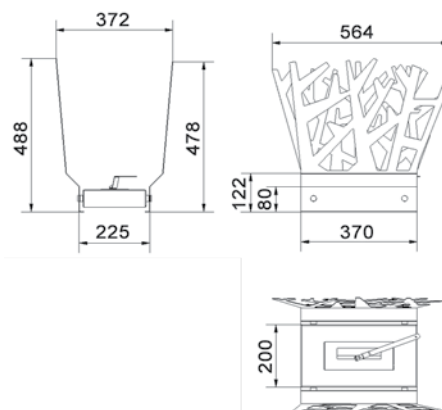

 5
  0,4
 
 stal czarna malowana / black painted steel / Schwarzstahl gestrichen / черная сталь с окраской / černý plech / acier noir peint / μαύρος χάλυβας βαμμένος / lamiera verniciata nera / acero negro pintado



HOTEL MINI KRZAK



 6
  0,4
 
 stal czarna malowana / black painted steel / Schwarzstahl gestrichen / черная сталь с окраской / černý plech / acier noir peint / μαύρος χάλυβας βαμμένος / lamiera verniciata nera / acero negro pintado

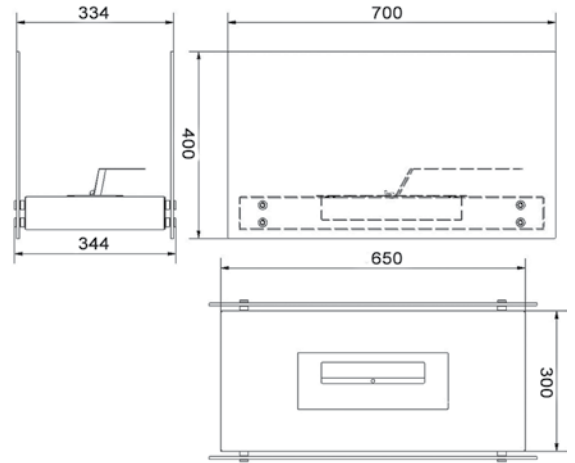
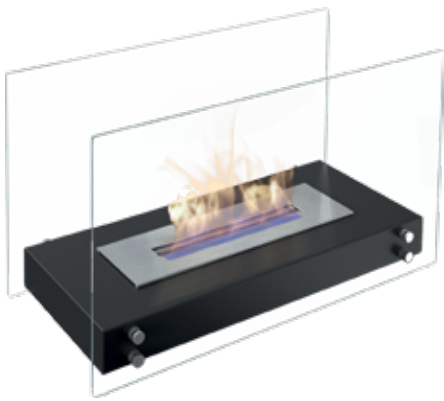

HOTEL

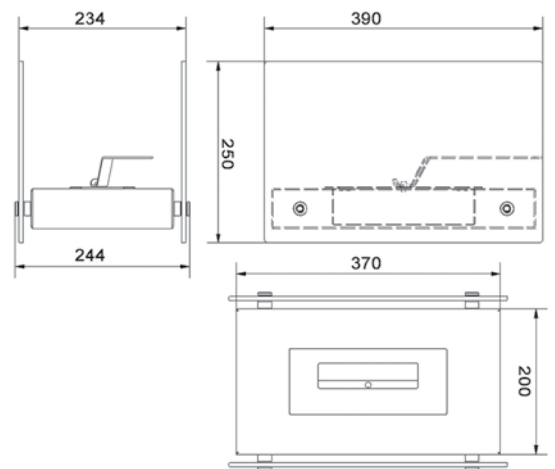
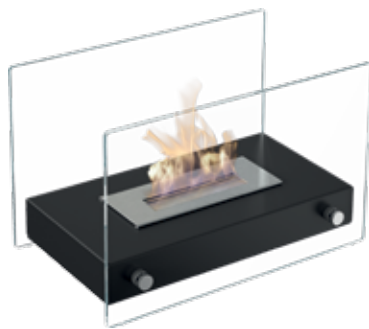

 15,5  1,2  stal czarna malowana, szkło / black painted steel, glass / Glas, Holz / черная сталь с окраской, стекло / černý plech, sklo / acier noir peint, verre / μαύρος χάλυβας βαμμένος, γυαλί / lamiera verniciata nera, vetro / acero negro pintado, cristal

HOTEL MINI





 6  0,4  stal czarna malowana, szkło / black painted steel, glass / Glas, Holz / черная сталь с окраской, стекло / černý plech, sklo / acier noir peint, verre / μαύρος χάλυβας βαμμένος, γυαλί / lamiera verniciata nera, vetro / acero negro pintado, cristal



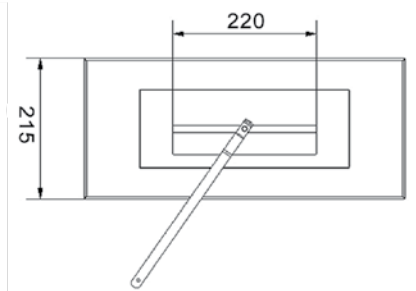
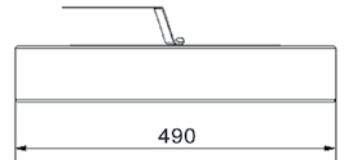
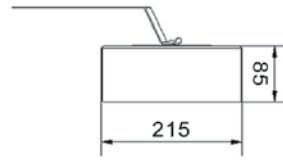



INDIA

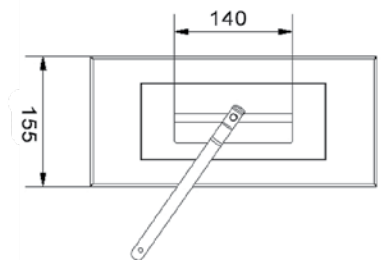
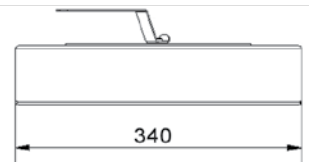
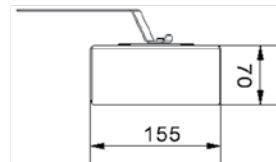
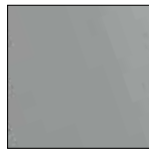

 4  1,2  stal czarna malowana / black painted steel / Schwarzstahl gestrichen / черная сталь с окраской / černý plech / acier noir peint / μαύρος χάλυβας βαμμένος / lamiera verniciata nera / acero negro pintado



INDIA MINI



 2  0,4  stal czarna malowana / black painted steel / Schwarzstahl gestrichen / черная сталь с окраской / černý plech / acier noir peint / μαύρος χάλυβας βαμμένος / lamiera verniciata nera / acero negro pintado

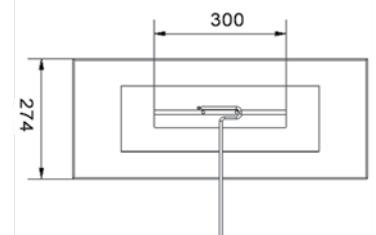
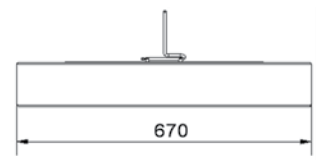
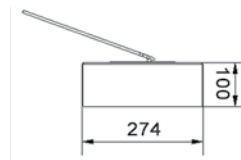
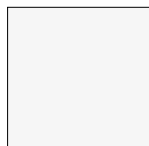

INDIA MAX



 7  1,6  stal czarna malowana / black painted steel / Schwarzstahl gestrichen / черная сталь с окраской / černý plech / acier noir peint / μαύρος χάλυβας βαμμένος / lamiera verniciata nera / acero negro pintado

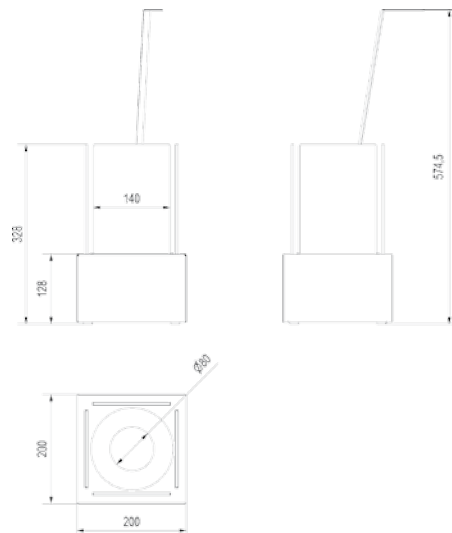

TANGO 1



 3,5
  0,44
 
 stal czarna malowana, szkło / black painted steel, glass / Glas, Holz / черная сталь с окраской, стекло / černý plech, sklo /
 acier noir peint, verre / μαύρος χάλυβας βαμμένος, γυαλί / lamiera verniciata nera, vetro / acero negro pintado, cristal

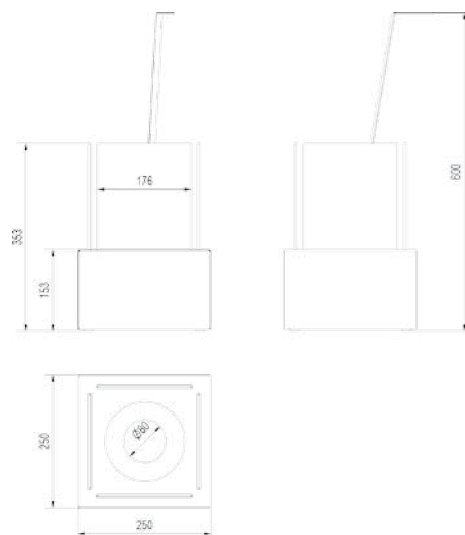

TANGO 2



 4,5
  0,44
 
 stal czarna malowana, szkło / black painted steel, glass / Glas, Holz / черная сталь с окраской, стекло / černý plech, sklo /
 acier noir peint, verre / μαύρος χάλυβας βαμμένος, γυαλί / lamiera verniciata nera, vetro / acero negro pintado, cristal

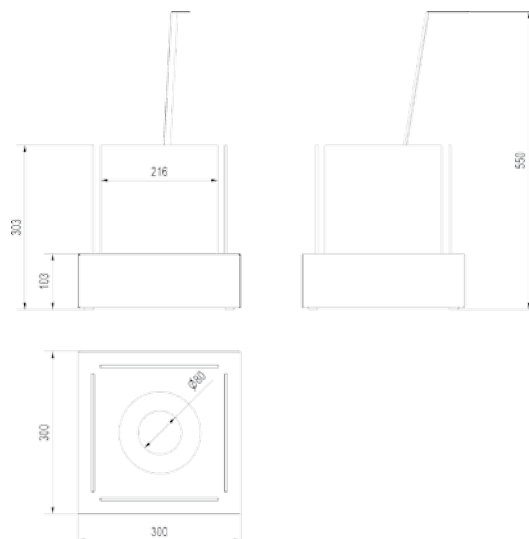
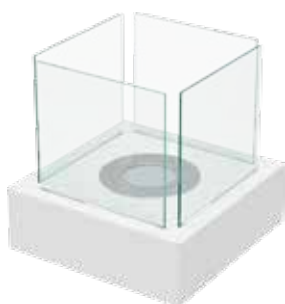

TANGO 3

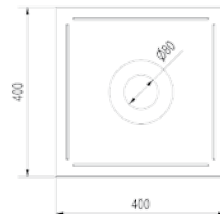

 4,6
  0,44
 
 stal czarna malowana, szkło / black painted steel, glass / Glas, Holz / черная сталь с окраской, стекло / černý plech, sklo /
 acier noir peint, verre / μαύρος χάλυβας βαμμένος, γυαλί / lamiera verniciata nera, vetro / acero negro pintado, cristal

TANGO 4





 9
  0,44
 
 stal czarna malowana, szkło / black painted steel, glass / Glas, Holz / черная сталь с окраской, стекло / černý plech, sklo /
 acier noir peint, verre / μαύρος χάλυβας βαμμένος, γυαλί / lamiera verniciata nera, vetro / acero negro pintado, cristal

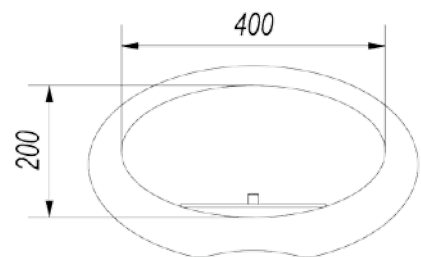
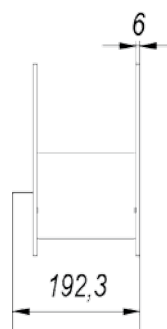

ECHO





 7,8
  0,4
 
 stal czarna malowana / black painted steel / Schwarzstahl gestrichen / черная сталь с окраской / černý plech / acier noir
 peint / μαύρος χάλυβας βαμμένος / lamiera verniciata nera / acero negro pintado



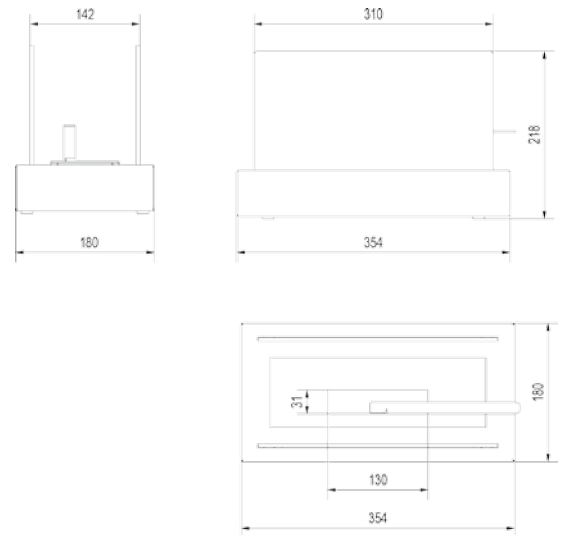



GALINA

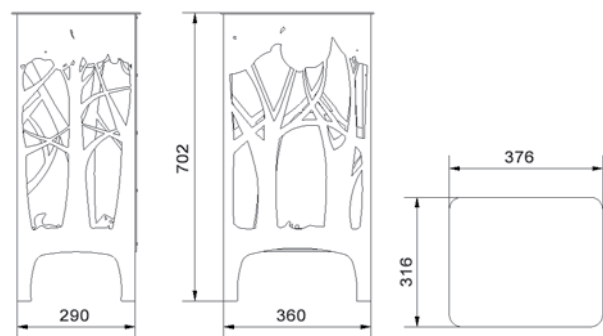

 4  0,5  stal czarna malowana, szkło / black painted steel, glass / Glas, Holz / черная сталь с окраской, стекло / černý plech, sklo / acier noir peint, verre / μαύρος χάλυβας βαμμένος, γυαλί / lamiera verniciata nera, vetro / acero negro pintado, cristal

FOXTROT



 15  0,4  stal czarna malowana / black painted steel / Schwarzstahl gestrichen / черная сталь с окраской / černý plech / acier noir peint / μαύρος χάλυβας βαμμένος / lamiera verniciata nera / acero negro pintado

MIKE

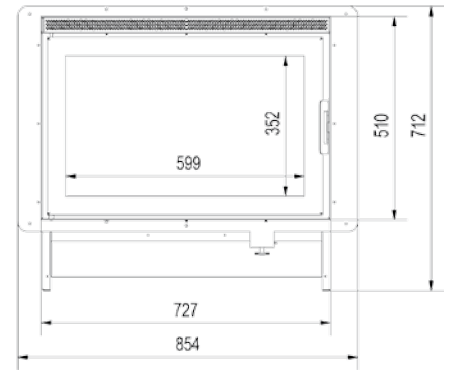
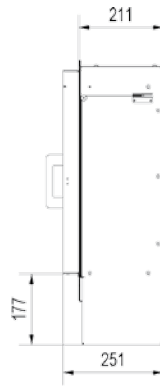

40



1,4



stal czarna malowana, szkło / black painted steel, glass / Glas, Holz / черная сталь с окраской, стекло / žerný plech, sklo /
acier noir peint, verre / μαύρος χάλυβας βαμμένος, γυαλί / lamiera verniciata nera, vetro / acero negro pintado, cristal



KILO

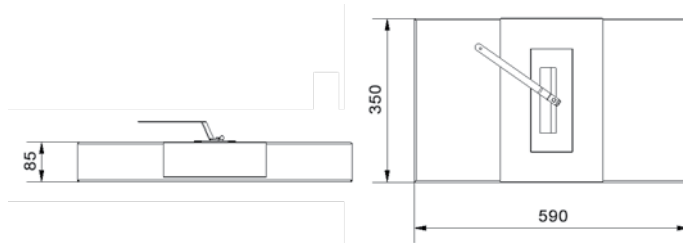

stal czarna malowana, stal szlifowana / black painted steel, inox tainless steel / Schwarzstahl gestrichen, Edelstahl / черная сталь с окраской, нержавеющей сталь / černý plech, nerez / tôle noire, tôle poncée / μαύρος χάλυβας, inox χάλυβας / lamiera verniciata nera, acciaio inox / acero negro pintado, acero inoxidable



JULIET

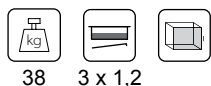
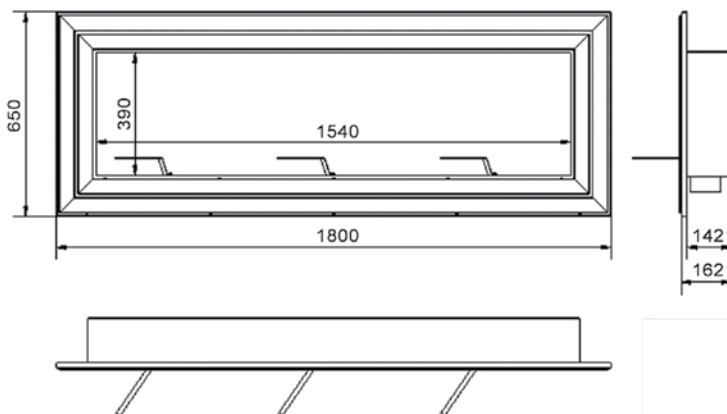

stal czarna malowana, stal szlifowana / black painted steel, inox tainless steel / Schwarzstahl gestrichen, Edelstahl / черная сталь с окраской, нержавеющей сталь / černý plech, nerez / tôle noire, tôle poncée / μαύρος χάλυβας, inox χάλυβας / lamiera verniciata nera, acciaio inox / acero negro pintado, acero inoxidable



JULIET 1500

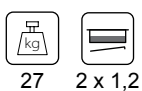
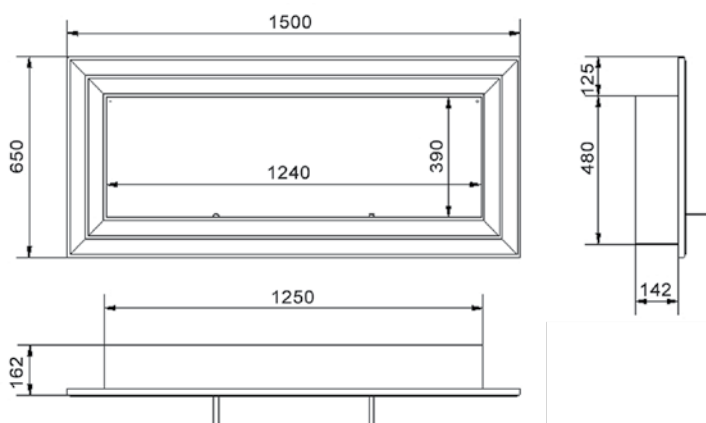

stal czarna malowana, stal szlifowana / black painted steel, inox tainless steel / Schwarzstahl gestrichen, Edelstahl / черная сталь с окраской, нержавеющей сталь / černý plech, nerez / tôle noire, tôle poncée / μαύρος χάλυβας, inox χάλυβας / lamiera verniciata nera, acciaio inox / acero negro pintado, acero inoxidable

JULIET 1100

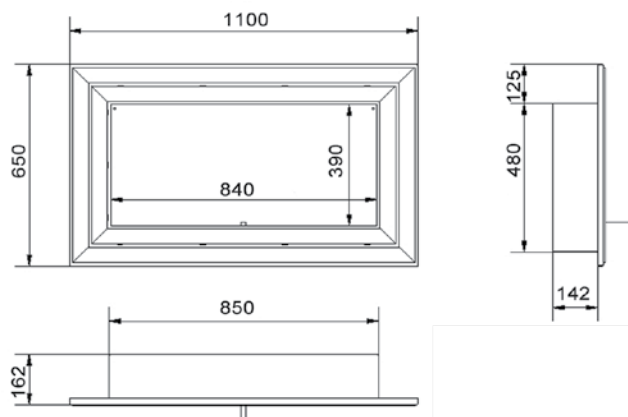



stal czarna malowana, stal szlifowana / black painted steel, inox tainless steel / Schwarzstahl gestrichen, Edelstahl / черная сталь с окраской, нержавеющей сталь / černý plech, nerez / tôle noire, tôle poncée / μαύρος χάλυβας, inox χάλυβας / lamiera verniciata nera, acciaio inox / acero negro pintado, acero inoxidable



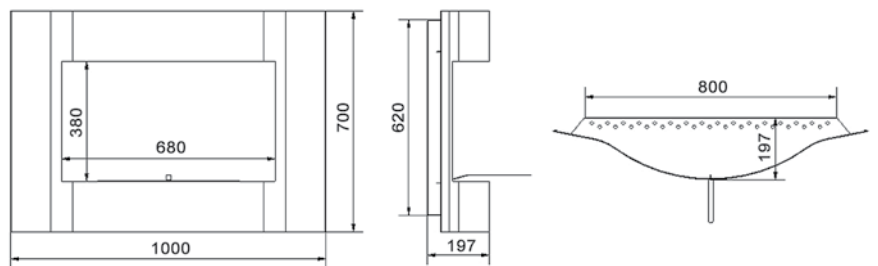



LIMA

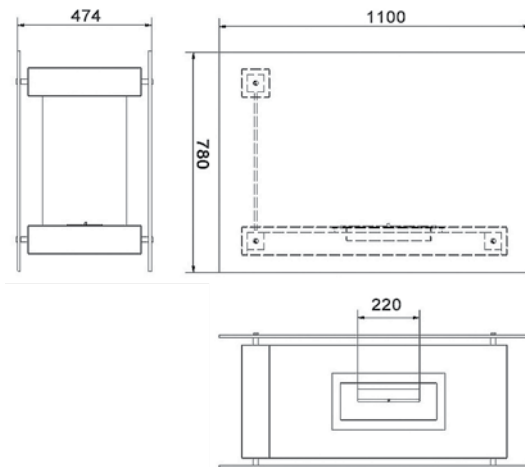
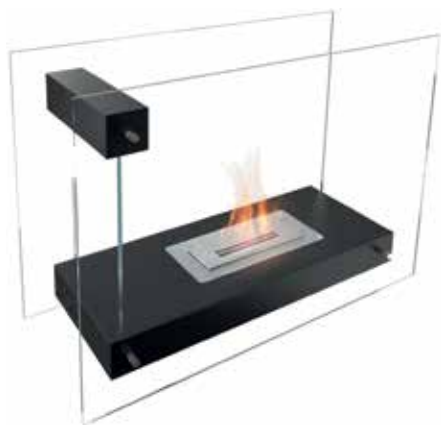

 22,6
  1,1
 
 stal czarna malowana, stal szlifowana / black painted steel, inox tainless steel / Schwarzstahl gestrichen, Edelstahl / черная сталь с окраской, нержавеющей сталь / černý plech, nerez / tôle noire, tôle poncée / μαύρος χάλυβας, inox χάλυβας / lamiera verniciata nera, acciaio inox / acero negro pintado, acero inoxidable

LINATE



   fornir, szkło / veneer, glass / Glas, Holz / Стекло, дерево / дýha, sklo / bois de placage, verre / ξύλο, γυαλί / impiallacciato, vetro / chapa imitación madera, cristal

61 1,2

Pozostale kolory LINATE dostępane na zamówienie: / Other colours LINATE available on request: / Weitere Furniervarianten erhältlich auf Bestellung: / Варианты текстуры под заказ: / Ostatní barvy na objednávku: / Autres couleurs disponibles sur commande: / Επιπλέον χρώματα διαθέσιμα με παραγγελία: / Altri colori disponibili su richiesta: / Otros colores LINATE disponibles bajo pedido:

	Orzech naturalny Natural walnut Nuss Натуральный орех Ofech prírodný Noyer naturel Καρυδιά Noce naturale Nogal		Teak Тик Teca		Bariole limba Bariole pine Bariole limba Bariole кедр Limba bariole Bariole limba Πεύκο beriole Bariole limba Pino Bariole		Orzech pasiak Striped walnut Nuss gestreift Орех полосатый Ofech pásomový Noyer rayure Καρυδιά με νερά Noce striato Nogal ceniza		Zebrano jasne Light Zebrano Zebrano hell Зебрано-светлый Zebrawood světlý Zebrano clair Zebrano ανοιχτόχρωμο Zebrano chiaro Zebra claro
	Krwiste drzewo Bloody tree Blutbaum Красное дерево Bois rouge Bloody tree Ξύλο κόκκινο Sanguinoso Albero Terracota		Wenge Венге Βέγκε Wengué		Heban Ebony Ebenholz Чёрное дерево Eben Ebène Ebenholz Ebano Ébano		Dąb bielony Bleached oak Eiche weiß беленый дуб Dub bělený Chêne blanc Βελανιδιά λευκή Quercia sbiancato Roble blanqueado		Zebrano ciemne Dark Zebrano Zebrano dunkel Зебрано-тёмный Zebrawood tmavý Zebrano foncé Zebrano σκούρο Zebrano scuro Zebra oscuro

Stoje oraz kolory forniru widoczne na zdjeciach mogą nieznacznie odbiegać od klejny znajdujacej się w sprzedazy. Przedstawiona kolorystykę należy traktować jako przybliżoną.
Jars and colors of veneer may be slightly different from the dashboard located in current sale. Colouring set out should be considered as an approximate.

Die Maserungen und Farben der Portalrahmen aus Furnier auf den Fotos können von dem gelieferten Produkt etwas abweichen. Die dargestellten Farben sollte man als Beispiel betrachten.
Варианты текстуры, показанные на фотографиях, могут незначительно отличаться от реальной. Их следует рассматривать как приближительные.

Žilky a barvy na snímcích portálových rámu se mohou do jisté míry lišit od dýha, která je současně v prodeji. Vyobrazená barevná provedení jsou pouze přibližná.

Les cernes de bois et les couleurs sur les photos de cadres de placage peuvent légèrement diverger du placage en vente. Photos à titre indicatif seulement.



Τα νερά και χρώματα των ξύλινων πλαίσιων μπορούν να διαφέρουν ελαφρώς από την πραγματική τους μορφή. Τα δείγματα παρουσιάζονται κατά προσέγγιση.

Struttura e colori sulle foto del quadro impiallacciatura portale ossono differire leggermente da impiallacciatura situato in vendita. Colori indicati devono essere considerati come indicativi.

La textura y los colores de las muestras pueden diferir ligeramente del acabado original.

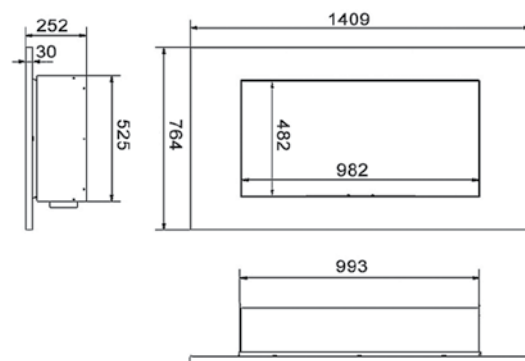
MILA Z RAMĄ SZLIFOWANĄ / STEEL FRAME / PORTALRAHMEN GESCHLIFFEN / ПЛЮС СТАЛЬНЫЙ ПОРТАЛ / S NEREZOVÝM BROUŠENÝM RÁMEM / STEEL FRAME / AVEC CADRE EN ACIER PONCÉ / ME ΠΛΑΙΣΙΟ INOX / INOX / MARCO EN ACERO INOXIDABLE





   stal czarna malowana, stal szlifowana / black painted steel, inox tainless steel / Schwarzstahl gestrichen, Edelstahl / черная сталь с окраской, нержавеющей сталь / černý plech, nerez / tôle noire, tôle poncée / μαύρος χάλυβας, inox χάλυβας / lamiera verniciata nera, acciaio inox / acero negro pintado, acero inoxidable

23 1,6

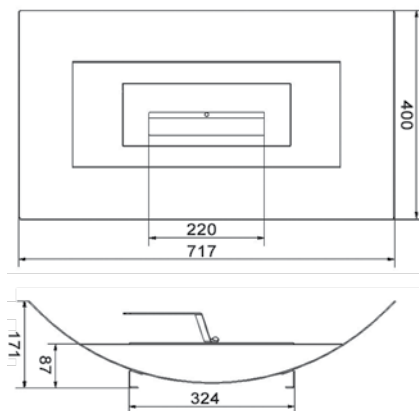
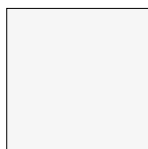

MISA

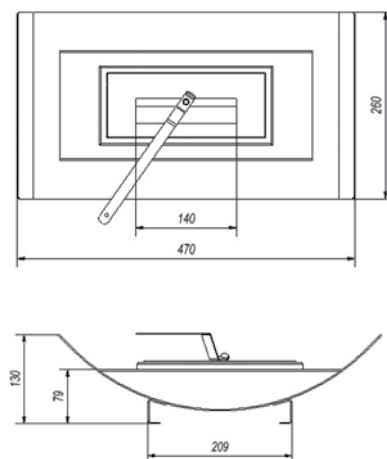

 8,5  1,2  stal czarna malowana / black painted steel / Schwarzstahl gestrichen / черная сталь с окраской / černý plech / acier noir peint / μαύρος χάλυβας βαμμένος / lamiera verniciata nera / acero negro pintado

MISA MINI



 4  0,4  stal czarna malowana / black painted steel / Schwarzstahl gestrichen / черная сталь с окраской / černý plech / acier noir peint / μαύρος χάλυβας βαμμένος / lamiera verniciata nera / acero negro pintado



ROMEO

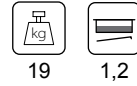
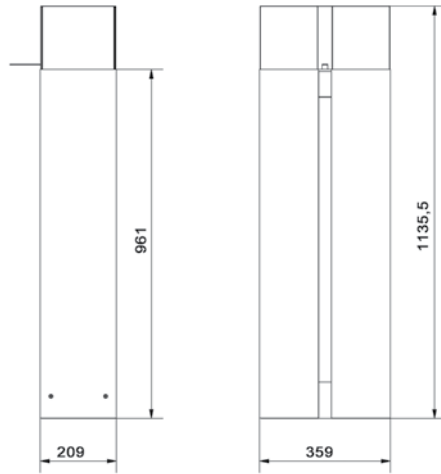

stal czarna malowana, stal szlifowana, szkło
 black painted steel, inox tainless steel, glass
 Schwarzstahl gestrichen, Edelstahl, Glas
 черная сталь с окраской, нержавеющей сталь, стекло
 černý plech, nerez, sklo / tôle noire, tôle poncée, verre
 μαύρος χάλυβας, inox χάλυβας, γυαλί
 lamiera verniciata nera, acciaio inox, vetro
 acero negro pintado, acero inoxidable, cristal



SIERRA

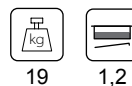
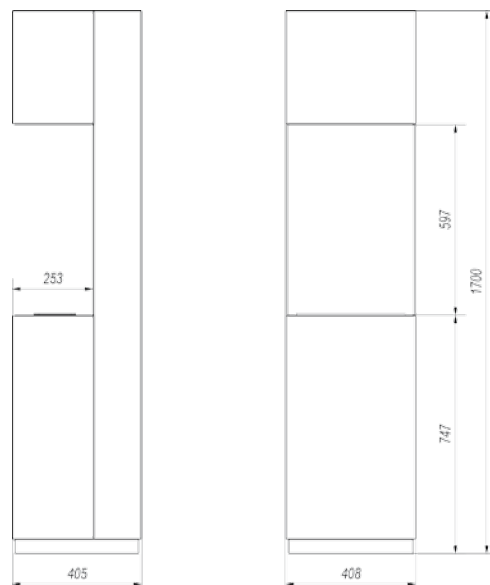

stal czarna malowana, MDF biały
 black painted steel, MDF white
 Schwarzstahl gestrichen, MDF weiß
 черная сталь с окраской, MDF белый
 černý plech, MDF bílý
 acier noir peint, MDF blanche
 μαύρος χάλυβας βαμμένος, MDF λευκό
 lamiera verniciata nera, MDF bianco
 acero negro pintado, MDF blanco

QUAT



VERTICAL



HORIZONTAL





QUBE



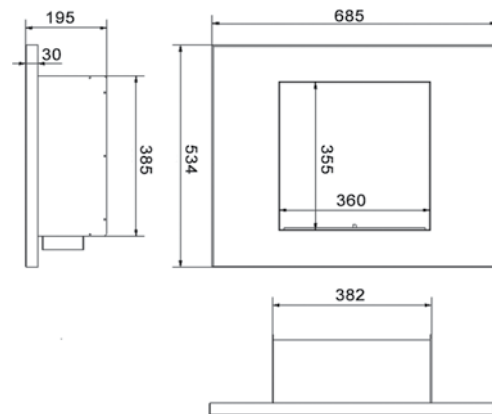



SZLIF

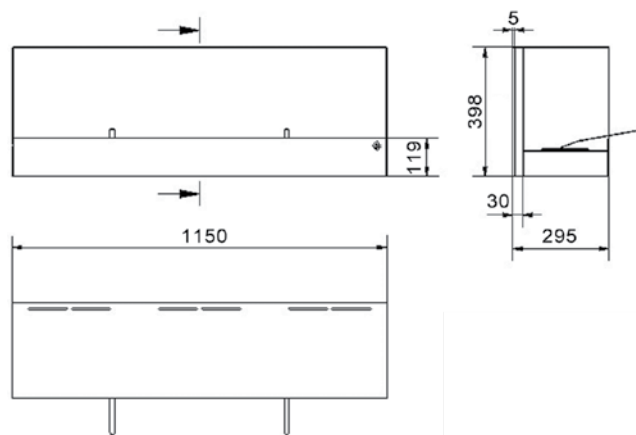

 11
  1,2
 
 stal czarna malowana / black painted steel / Schwarzstahl gestrichen / черная сталь с окраской / černý plech / acier noir peint / μαύρος χάλυβας βαμμένος / lamiera verniciata nera / acero negro pintado

QUEBEC





 45
  2 x 1,6
 
 stal czarna malowana / black painted steel / Schwarzstahl gestrichen / черная сталь с окраской / černý plech / acier noir peint / μαύρος χάλυβας βαμμένος / lamiera verniciata nera / acero negro pintado

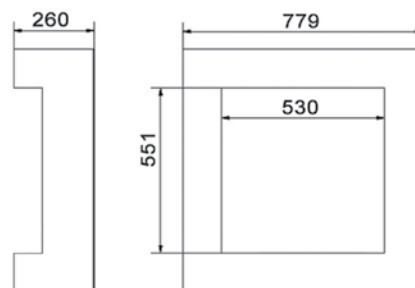

BIOKOMINEK DUŻY / Biofireplace big / Biokamin groß / большой био-камин / Biokrb AF / Bio-cheminée Grande / Τζάκι βιοκαυσίμου μεγάλο / Biocaminetto semicircolare / Biochimenea semicircular





 21  1,2  stal czarna malowana, stal szlifowana / black painted steel, inox tainless steel / Schwarzstahl gestrichen, Edelstahl / черная сталь с окраской, нержавеющей сталь / černý plech, nerez / tôle noire, tôle poncée / μαύρος χάλυβας, inox χάλυβας / lamiera verniciata nera, acciaio inox / acero negro pintado, acero inoxidable



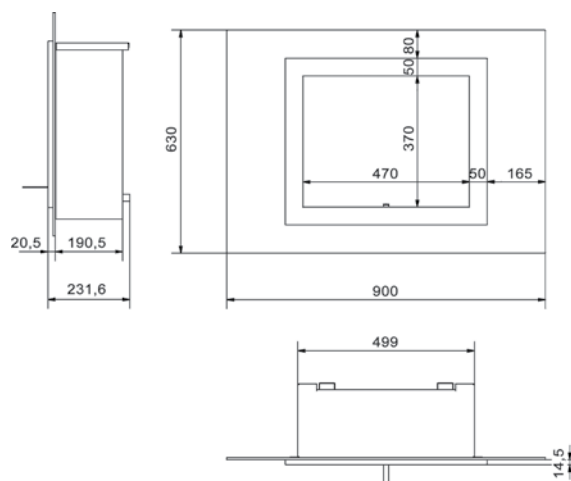



OSCAR

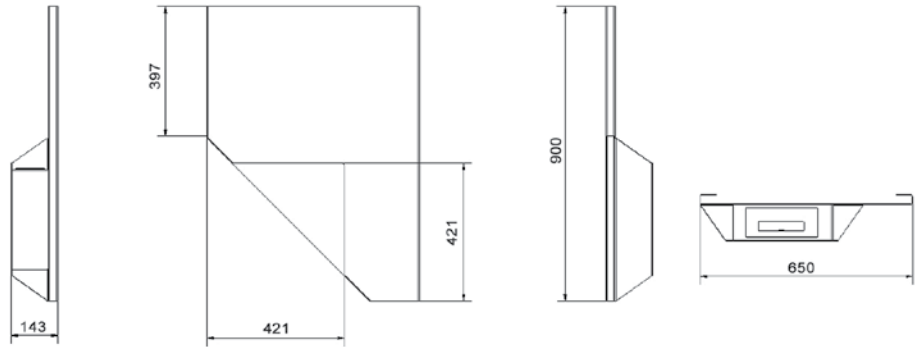

 19  1,2  stal czarna malowana, szkło / black painted steel, glass / Glas, Holz / черная сталь с окраской, стекло / černý plech, sklo / acier noir peint, verre / μαύρος χάλυβας βαμμένος, γυαλί / lamiera verniciata nera, vetro / acero negro pintado, cristal



PAPA



 12
  0,4
 
 stal czarna malowana / black painted steel / Schwarzstahl gestrichen / черная сталь с окраской / černý plech / acier noir
 peint / μαύρος χάλυβας βαμμένος / lamiera verniciata nera / acero negro pintado

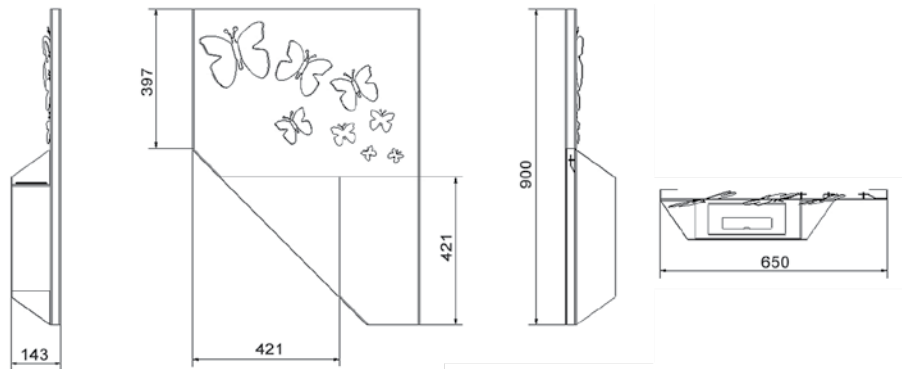

PAPA MORPHO z kamieniami Swarovskiego

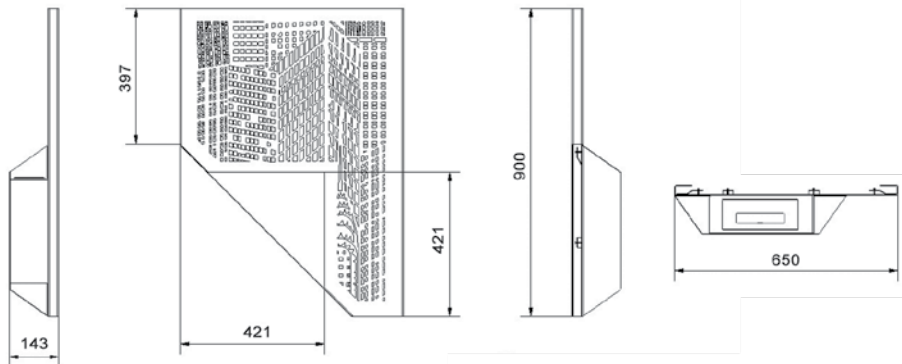

 12,5
  0,4
 
 stal czarna malowana / black painted steel / Schwarzstahl gestrichen / черная сталь с окраской / černý plech / acier noir
 peint / μαύρος χάλυβας βαμμένος / lamiera verniciata nera / acero negro pintado

PAPA MANHATTAN





 13,5
  0,4
 
 stal czarna malowana / black painted steel / Schwarzstahl gestrichen / черная сталь с окраской / černý plech / acier noir
 peint / μαύρος χάλυβας βαμμένος / lamiera verniciata nera / acero negro pintado



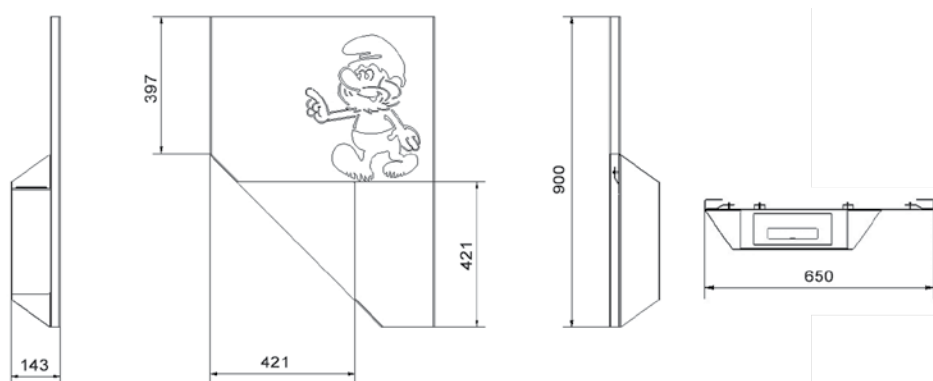



PAPA SMERF

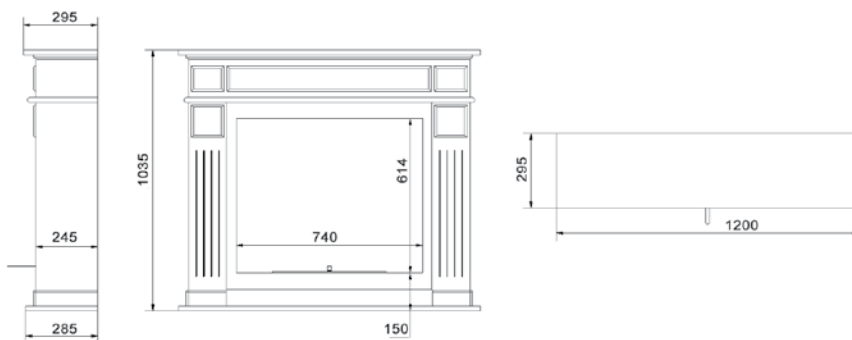

 12,7
  0,4
  stal czarna malowana / black painted steel / Schwarzstahl gestrichen / черная сталь с окраской / černý plech / acier noir peint / μαύρος χάλυβας βαμμένος / lamiera verniciata nera / acero negro pintado



NOVEMBER

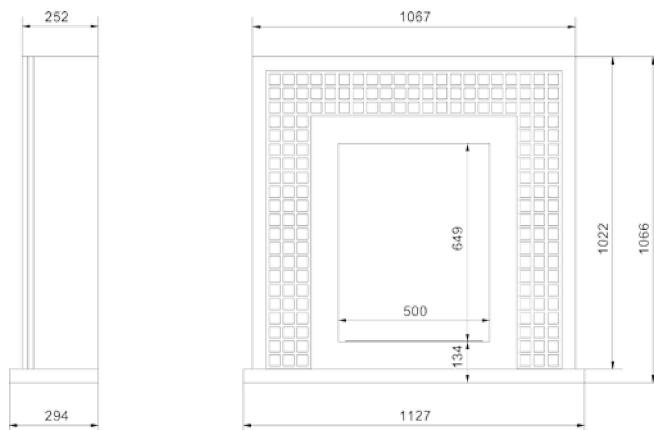

 52
  1,6
 
 stal czarna malowana, MDF biały / black painted steel, MDF white / Schwarzstahl gestrichen, MDF weiß / черная сталь с окраской, MDF белый / černý plech, MDF bílý / acier noir peint, MDF blanche / μαύρος χάλυβας βαμμένος, MDF λευκό / lamiera verniciata nera, MDF bianco / acero negro pintado, MDF blanco

JANUARY



 52
  1,6
 
 stal czarna malowana, MDF biały / black painted steel, MDF white / Schwarzstahl gestrichen, MDF weiß / черная сталь с окраской, MDF белый / černý plech, MDF bílý / acier noir peint, MDF blanche / μαύρος χάλυβας βαμμένος, MDF λευκό / lamiera verniciata nera, MDF bianco / acero negro pintado, MDF blanco





EGZUL

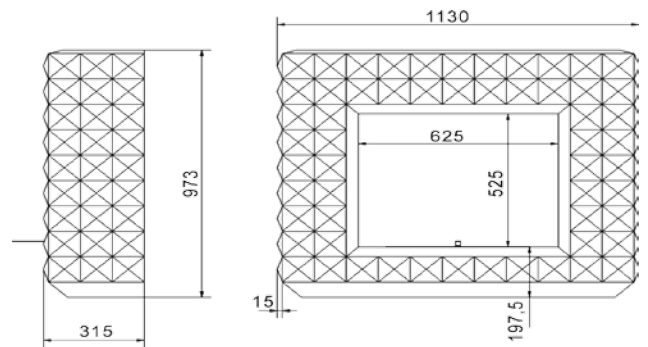
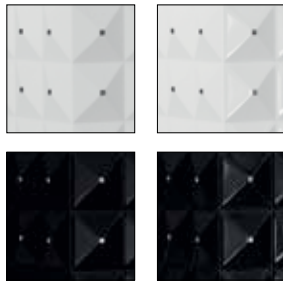

68,5 1,6

stal czarna malowana, MDF biały / black painted steel, MDF white / Schwarzzstahl gestrichen, MDF weiß / черная сталь с окраской, MDF белый / černý plech, MDF bílý / acier noir peint, MDF blanche / μαύρος χάλυβας βαμμένος, MDF λευκό / lamiera verniciata nera, MDF bianco / acero negro pintado, MDF blanco

FEBRUARY

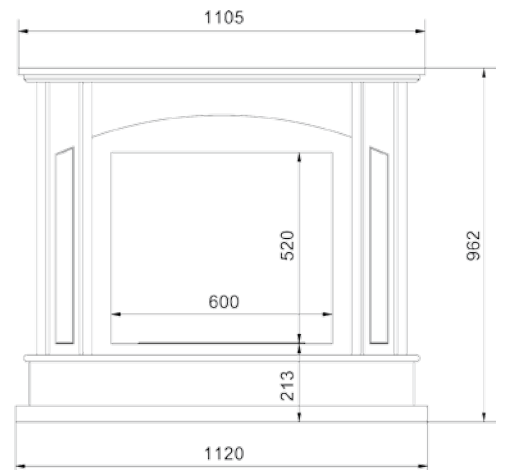





54 1,6

stal czarna malowana, MDF biały / black painted steel, MDF white / Schwarzzstahl gestrichen, MDF weiß / черная сталь с окраской, MDF белый / černý plech, MDF bílý / acier noir peint, MDF blanche / μαύρος χάλυβας βαμμένος, MDF λευκό / lamiera verniciata nera, MDF bianco / acero negro pintado, MDF blanco

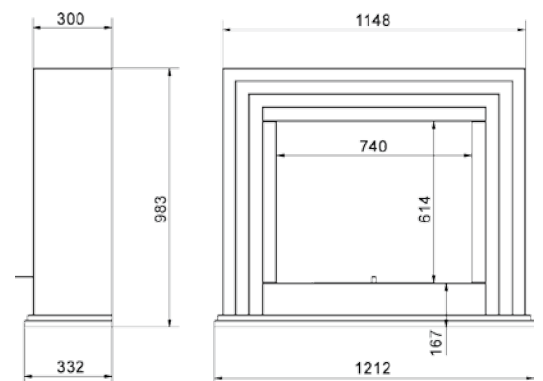





QUAERERE

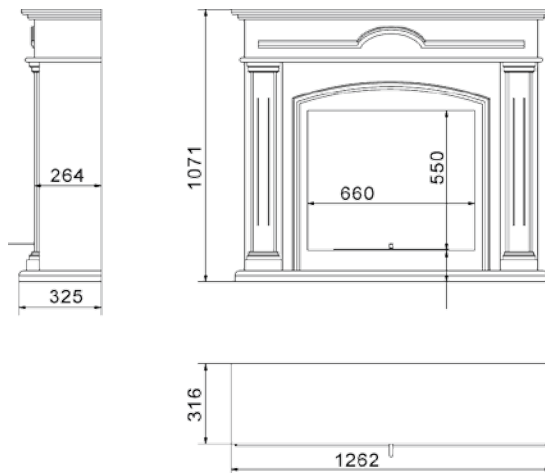

 63,5
  1,6
 
 stal czarna malowana, MDF biały / black painted steel, MDF white / Schwarzstahl gestrichen, MDF weiß / черная сталь с окраской, MDF белый / černý plech, MDF bílý / acier noir peint, MDF blanche / μαύρος χάλυβας βαμμένος, MDF λευκό / lamiera verniciata nera, MDF bianco / acero negro pintado, MDF blanco



DECEMBER

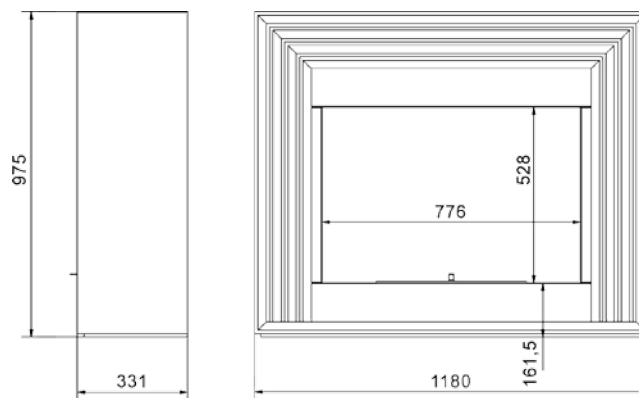

 64
  1,6
  stal czarna malowana, MDF biały / black painted steel, MDF white / Schwarzstahl gestrichen, MDF weiß / черная сталь с окраской, MDF белый / černý plech, MDF bílý / acier noir peint, MDF blanche / μαύρος χάλυβας βαμμένος, MDF λευκό / lamiera verniciata nera, MDF bianco / acero negro pintado, MDF blanco

PLANET







 81
  1,6
  stal czarna malowana, MDF biały / black painted steel, MDF white / Schwarzstahl gestrichen, MDF weiß / черная сталь с окраской, MDF белый / černý plech, MDF bílý / acier noir peint, MDF blanche / μαύρος χάλυβας βαμμένος, MDF λευκό / lamiera verniciata nera, MDF bianco / acero negro pintado, MDF blanco



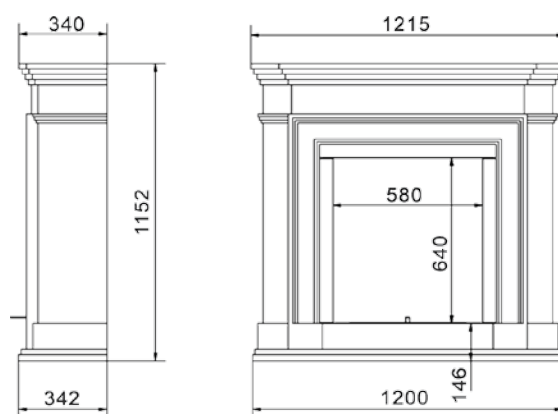





LEGIONIS

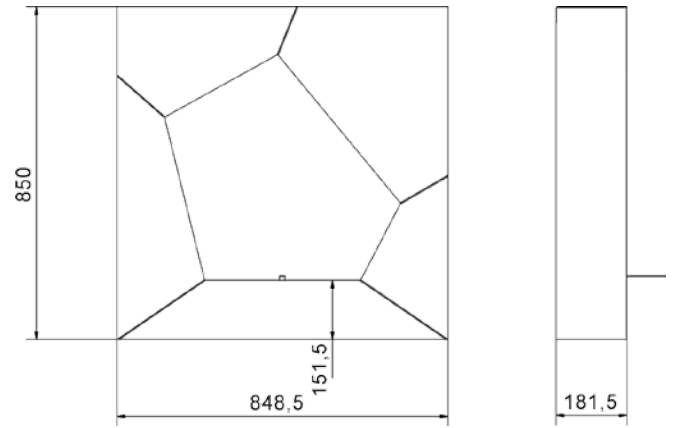

 85
  1,6
 
 stal czarna malowana, MDF biały / black painted steel, MDF white / Schwarzstahl gestrichen, MDF weiß / черная сталь с окраской, MDF белый / černý plech, MDF bílý / acier noir peint, MDF blanche / μαύρος χάλυβας βαμμένος, MDF λευκό / lamiera verniciata nera, MDF bianco / acero negro pintado, MDF blanco

BALL





 28,5
  1,2
 
 stal czarna malowana, MDF biały / black painted steel, MDF white / Schwarzstahl gestrichen, MDF weiß / черная сталь с окраской, MDF белый / černý plech, MDF bílý / acier noir peint, MDF blanche / μαύρος χάλυβας βαμμένος, MDF λευκό / lamiera verniciata nera, MDF bianco / acero negro pintado, MDF blanco



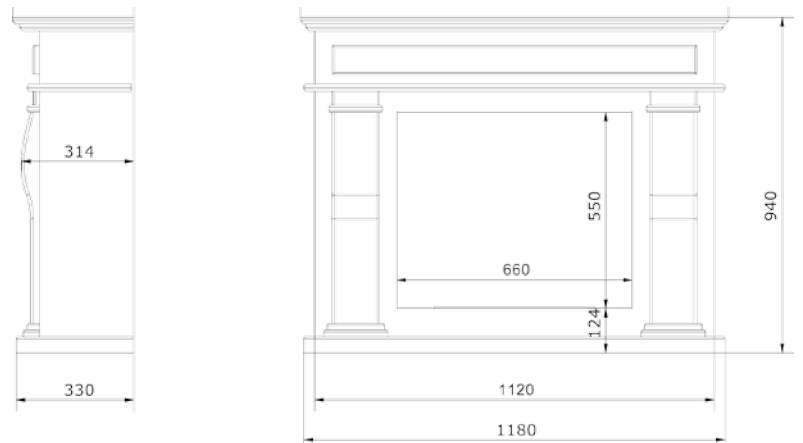



OCTOBER

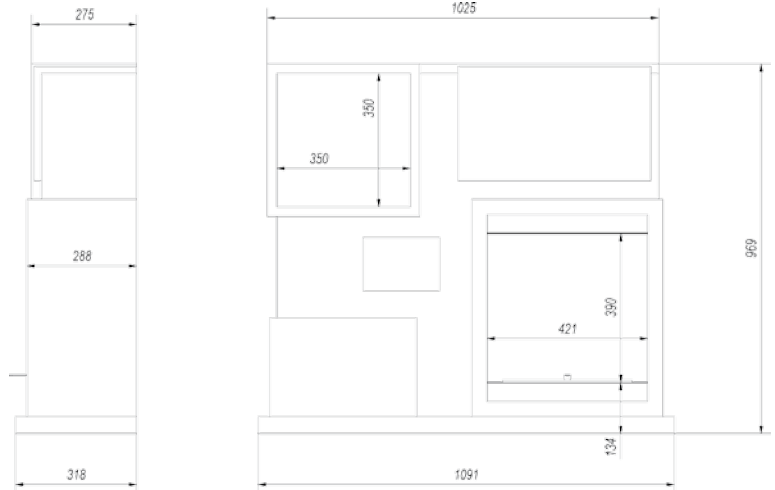

 56
  1,6
 
 stal czarna malowana, MDF biały / black painted steel, MDF white / Schwarzstahl gestrichen, MDF weiß / черная сталь с окраской, MDF белый / černý plech, MDF bílý / acier noir peint, MDF blanche / μαύρος χάλυβας βαμμένος, MDF λευκό / lamiera verniciata nera, MDF bianco / acero negro pintado, MDF blanco



JULY

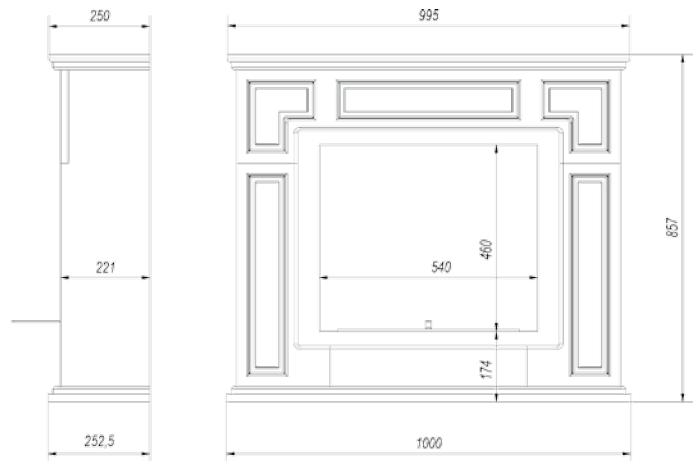

 55
  1,2
 
 stal czarna malowana, MDF biały / black painted steel, MDF white / Schwarzstahl gestrichen, MDF weiß / черная сталь с окраской, MDF белый / černý plech, MDF bílý / acier noir peint, MDF blanche / μαύρος χάλυβας βαμμένος, MDF λευκό / lamiera verniciata nera, MDF bianco / acero negro pintado, MDF blanco

MARCH



 49
  1,6
 
 stal czarna malowana, MDF biały / black painted steel, MDF white / Schwarzstahl gestrichen, MDF weiß / черная сталь с окраской, MDF белый / černý plech, MDF bílý / acier noir peint, MDF blanche / μαύρος χάλυβας βαμμένος, MDF λευκό / lamiera verniciata nera, MDF bianco / acero negro pintado, MDF blanco





APRIL

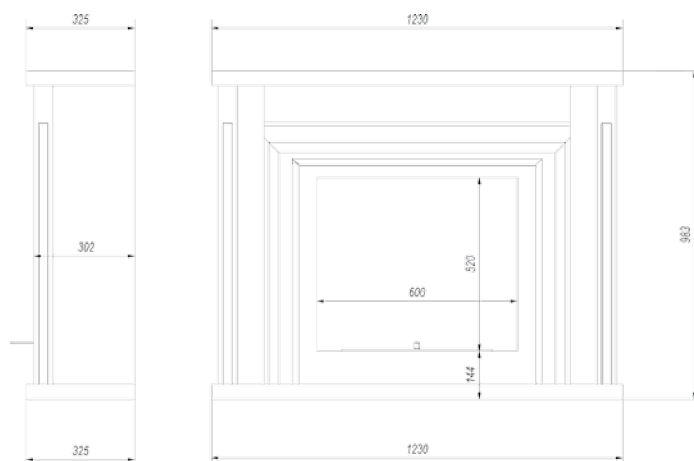



stal czarna malowana, MDF biały / black painted steel, MDF white / Schwarzstahl gestrichen, MDF weiß / черная сталь с окраской, MDF белый / černý plech, MDF bílý / acier noir peint, MDF blanche / μαύρος χάλυβας βαμμένος, MDF λευκό / lamiera verniciata nera, MDF bianco / acero negro pintado, MDF blanco



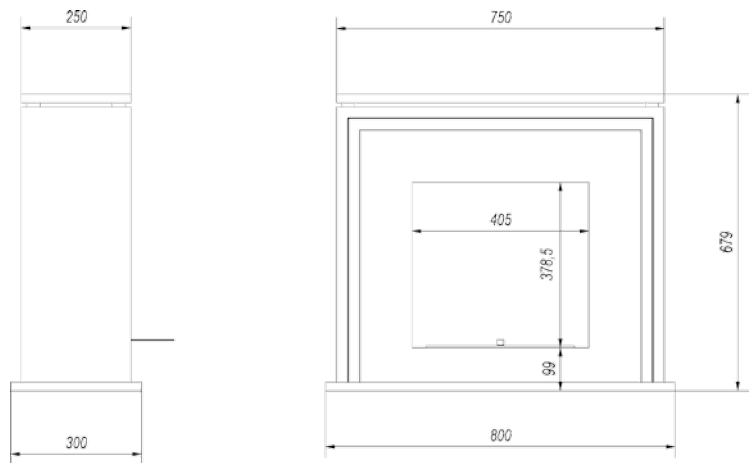



JUNE

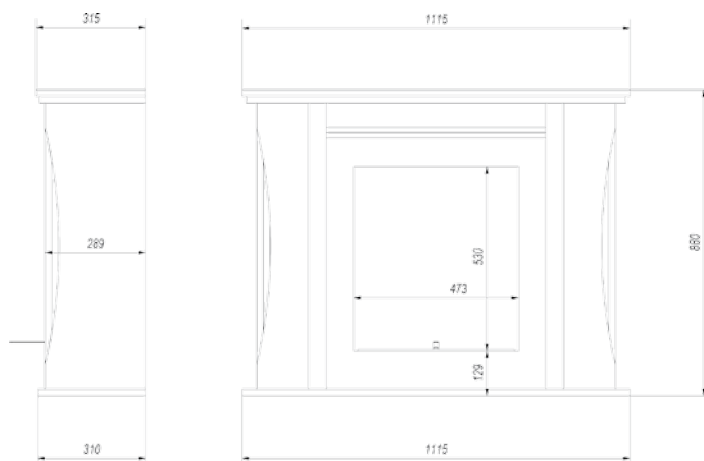

 31
  1,2
 
 stal czarna malowana, MDF biały / black painted steel, MDF white / Schwarzstahl gestrichen, MDF weiß / черная сталь с окраской, MDF белый / černý plech, MDF bílý / acier noir peint, MDF blanche / μαύρος χάλυβας βαμμένος, MDF λευκό / lamiera verniciata nera, MDF bianco / acero negro pintado, MDF blanco

MAY





 54
  1,6
 
 stal czarna malowana, MDF biały / black painted steel, MDF white / Schwarzstahl gestrichen, MDF weiß / черная сталь с окраской, MDF белый / černý plech, MDF bílý / acier noir peint, MDF blanche / μαύρος χάλυβας βαμμένος, MDF λευκό / lamiera verniciata nera, MDF bianco / acero negro pintado, MDF blanco

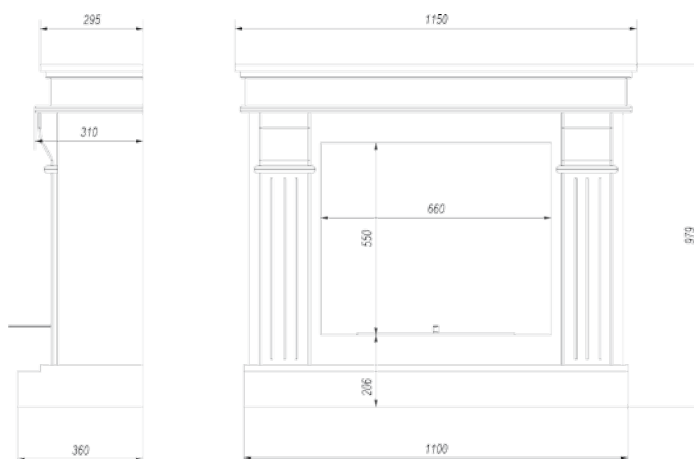

AUGUST



 67
  1,6
 
 stal czarna malowana, MDF biały / black painted steel, MDF white / Schwarzstahl gestrichen, MDF weiß / черная сталь с окраской, MDF белый / černý plech, MDF bílý / acier noir peint, MDF blanche / μαύρος χάλυβας βαμμένος, MDF λευκό / lamiera verniciata nera, MDF bianco / acero negro pintado, MDF blanco

ELEMENTY DO BIOKOMINKÓW

Elements for bio fireplaces / Elemente für die Biokamine / Аксессуары для биокаминов / Příslušenství k biokrbům / Eléments pour bio-cheminées / Αξεσουάρ για Βιοτζάκια / Elementi per bio-camini / Accesorios para biochimeneas



Plyn BIO-DECO do stosowania w kominkach jako ekologiczne źródło energii. Nie wydziela zapachu, ani dymu. Został przebadany i zaaprobowany do użytkowania przez Narodowy Instytut Zdrowia Publicznego. 1 litr biopaliwa spala się od 2 do 5 godzin - w zależności od wielkości płomienia. Biopaliwo jest produktem polskim, w 100% ekologicznym.

BIO-DECO liquid is for bio fireplaces as an ecological source of energy. No odor or smoke. Has been tested and approved for use by the National Institute of Public Health. 1 liter of biofuel burns from 2 to 5 hours - depending on the size of the flame. It is a Polish product.

Der Biobrennstoff Bio-Deco geeignet für das Brennen in Kaminen als ökonomische Energiequelle. Von dem Bio-Ethanol entweicht kein Geruch und kein Qualm. Dieser Brennstoff wurde durch das Allgemeine Gesundheitsinstitut untersucht und attestiert. 1 Liter Brennstoff verbrennt innerhalb von 2 bis 5 Stunden - je nach der Flammengröße. Unser Biobrennstoff ist ein polnisches Produkt, 100% ökologisch.

Жидкость БИО-DECO предназначена для использования в биокаминах. Не выделяет при сгорании запаха или дыма. Был протестирован и принят к использованию через Narodowy Instytut Zdrowia Publicznego.

Расход 1-го литра биотоплива от 2 до 5 часов - в зависимости от размера пламени. Биотопливо является экологически чистым продуктом (производство Польша).

Hořlavá tekutina BIO-DECO k použití pro krby jako ekologický zdroj energie. Nevylučuje zápachy ani dým.

Byla přezkoušená a schválena Národním institutem veřejného zdraví pro topení v krbech. 1 litr biopaliva se spaluje 2-5 hodin podle velikosti plamene. BIO-DECO je polský výrobek, stoprocentně ekologický.

BIO-DECO éthanol pour bio-cheminée est une source d'énergie écologique. Il ne dégage pas d'odeur et ne produit pas de fumée. Il a été examiné et approuvé par l'Institut National de Santé Publique. 1 litre de bio-éthanol brûle de 2 à 5h, en fonction de la grandeur de flemme. Le biocombustible est un produit polonais, 100% écologique.

Το υγρό BIO-DECO χρησιμοποιείται στα τζάκια ως οικολογική πηγή ενέργειας. Δεν εκπέμπει οσμή ούτε καπνό.

Είναι εγκεκριμένο από το Εθνικό Ινστιτούτο Δημόσιας Υγείας. 1 λίτρο βιοκαυσίμου καταναλώνεται σε διάρκεια 2 έως 5 ωρών - ανάλογα την φλόγα. Το βιοκαύσιμο είναι πολωνικό προϊόν, 100% οικολογικό.

Liquid BIO-DECO per l'uso in camini come una risorsa pulita energia. Nessun odore, nessun fumo. È stato testato e approvato per l'uso da parte dell'Istituto Nazionale di Sanità Pubblica. 1 litri di biocarburante viene bruciato da 2 a 5 ore - a seconda delle dimensioni della fiamma. Carburante Bio è un prodotto polacco, 100% organico.

BIO-DECO es líquido bioetanol para las chimeneas y quemadores de Kratki. Fuente de energía ecológica, no huele ni desprende humos. Testado y aprobado por las Autoridades Sanitarias. 1 litro de bioetanol puede quemar de 2 a 5 horas, dependiendo de la llama. Producto de Polonia.



Nowe zapachy: leśny i kawa.

New fragrances: forest and coffee.

Neue Düfte: Wald und Kaffee.

Новые ароматы: лес и кофе.

Nové vůně: lesní a káva.

Deux nouveaux parfums: café et forêt.

Νέα Αρώματα: Δάσους ή καφέ.

Nuove fragranze: foresta e caffè.

Nuevas fragancias: bosque y café.



Bezpieczna i funkcjonalna zapalarka z możliwością regulacji płomienia oraz napełniania gazem.

Safe and functional lighter with adjustable flame and gas filling.

Sicherer und funktionaler Anzünder, mit der Flammenregulierungsfunktion, sowie auch dem Gasnachfüller.

Безопасная и функциональная зажигалка с возможностью регулировки пламени и дозаправки газом.

Bezpečný a funkční zapalovač s možností regulace velikosti plamene a naplňování plynem.

Briquet pour cheminée fonctionnel et sûr, rechargeable avec du gaz; possibilité de régler la flemme.

Ο ασφαλής και λειτουργικός αναπτήρας, με την δυνατότητα ρύθμισης φλόγας, καθώς και συμπλήρωσης υγραερίου.

Un'accensione sicura e funzionale, fiamma regolabile e il riempimento del gas.

Encendedor seguro y funcional, con llama regulable y recargable.



Drewienka ceramiczne do biokominków stanowią doskonałą ozdobę, zarówno biokominków wiszących, jak i stojących. Swoim wyglądem imitują różne rodzaje drzew. Odporne na wysokie temperatury.

Ceramic piece of wood for bio fireplaces are the perfect decoration for both hanging and standing bio fireplaces. They imitate different kinds of trees. Resistant to high temperatures.

Keramische Hölzchen für die Biokamine bilden eine ausgezeichnete Verzierung aller Biokamine. Sie ähneln den natürlichen Holzarten. Hitzebeständig.

Керамические «дрова» являются идеальным украшением как для настенных биокаминов, так и настольных (напольных). Они имитируют разные породы деревьев.

Устойчивы к высоким температурам.

Keramická polínka do biokrbů mohou být výbornou ozdobou jak závěsných, tak i volně stojících krbů.

Bûches décoratives en céramique pour bio-cheminées éthanol; résistantes aux hautes températures. Elles imitent les différentes essences de bois.

Τα κεραμικά ξύλα είναι εντυπωσιακό στοιχείο στα κρεμαστά και τα επιδαπέδια τζάκια βιοκαυσίμου. Μοιάζουν με διάφορα είδη δέντρων προσφέροντας μια μοναδική όψη. Ανθεκτικά σε υψηλές θερμοκρασίες.

Pezzo in ceramica di caminetti a legna sono la decorazione perfetta, caminetti sia appeso e in piedi. Il suo aspetto imitare diversi tipi di alberi. Resistente alle alte temperature.

Troncos cerámicos decorativos para biochimeneas de etanol, resistentes a altas temperaturas. Imitación de distintos tipos de leña.



Pojemnik biokominka do aromaterapii
Bio container for aromatherapy
Bio-Brenner zur Aromatherapie
Контейнер биокамина к ароматерапии
Veľký zásobník na biopalivo s aromaterapií
Vas rectangulaire à l'éthanol pour bio-cheminée avec l'aromathérapie
Δοχείο βιοκαυσίμου για αρωματοθεραπεία
Bruciatori con aromaterapia
Depósito con aromaterapia



Kamienie ozdobne mogą być umieszczone zarówno w biokominkach wiszących, jak i stojących. Doskonale podkreślają ich wygląd i dodają uroku. Są odporne na wysokie temperatury. Kolor biały.

Decorative stones can be placed both in hanging and standing bio fireplaces. Decorative stones give sophisticated look and add charm. They are resistant to high temperatures. Color / white.

Die dekorativen Steine können sowohl in den hängenden als auch in den stehenden Biokaminen plaziert werden. Sie heben das schicke Aussehen der Biokamine hervor, außerdem sind sie gegen hohe Temperaturen beständig. Farbe weiß.

Декоративные камни могут быть использованы как в настенных биокаминах, так и настольных (напольных). Отлично подчеркивают их дизайн и добавляют уюта. Устойчивы к высоким температурам. Белый цвет.

Dekoratívni kameny mohou být umístěné jak v biokrbech závěsných, tak i ve volně stojících. Dokonale zdůrazňují jejich vzhled a půvab. Jsou odolné proti vysokým teplotám. Barva bílá.

Pierres décoratives peuvent être placées aussi bien dans les bio-cheminées suspendues (à fixer au mur) que mobiles (à poser sur le sol). Les pierres accentuent l'aspect sophistiqué de la bio-cheminée et lui donnent du charme. Elles sont résistantes aux hautes températures. Couleur blanche.

Διακοσμητικές πέτρες, τοποθετούνται στα κρεμαστά και επιδαπέδια τζάκια βιοκαυσίμου. Προσφέρουν μια κομψή εμφάνιση και γοητεία. Ανθεκτικά σε υψηλές θερμοκρασίες. Διαθέσιμα σε λευκό χρώμα.

Pietre decorative può essere posizionato sia in biokominkach pensili e in piedi. Ideale migliorare il loro aspetto e aumentano il fascino. Sono resistenti alle alte temperature. Colore bianco.

Piedras decorativas que pueden sustituir a los leños simulados, disponible para todos los modelos. Las piedras dan un acento sofisticado a la chimenea con aspecto elegante. Resistentes a altas temperaturas. Color blanco.



muc & scott interiors

Kratki.pl Marek Bal

Wsola, ul. Warszawska 66, 26-660 Jedlińsk, Poland
tel. 00 48 48 340 10 00, 00 48 48 384 44 88, fax 00 48 48 384 44 88 wew. 106

www.kratki.com

